

# SMM 400

## Digital Meter Evaluation System

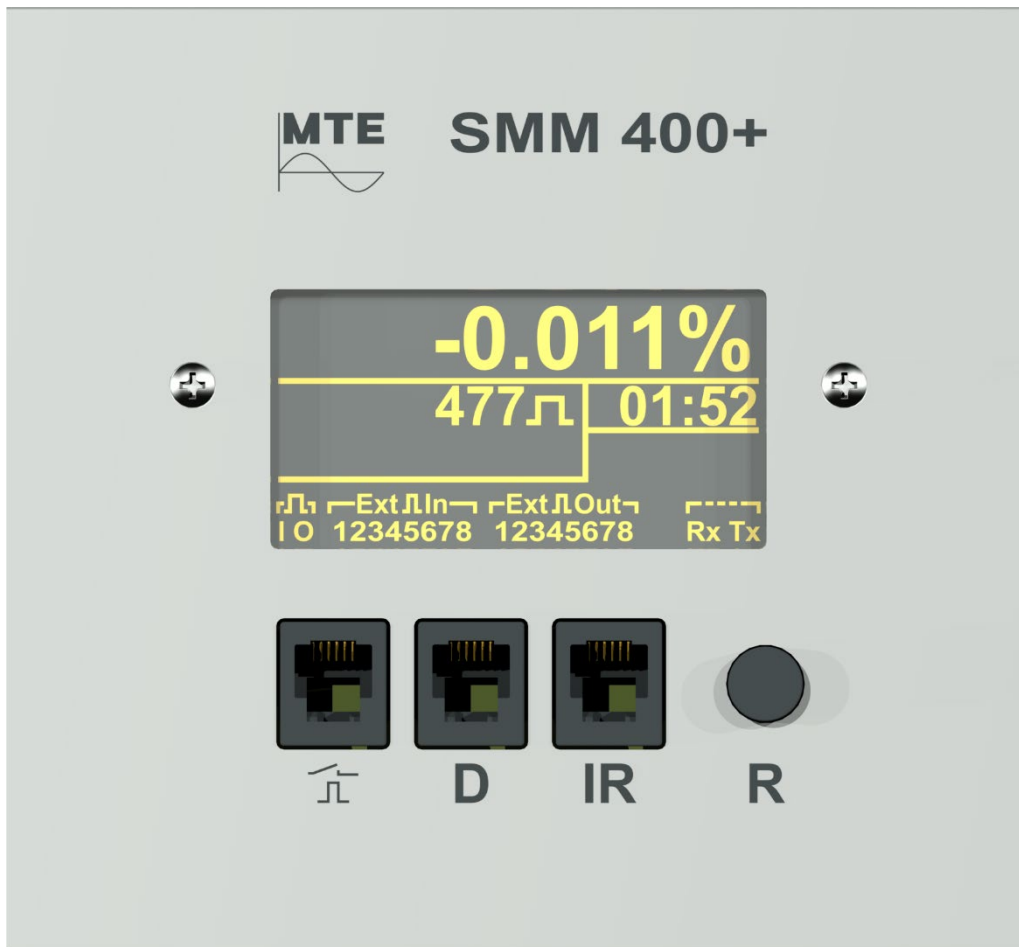

The modular Evaluation System **SMM 400** providing error calculation, testing of emitting contacts and communication to tariff device units to the meter under test.

Four different versions cover the customer requirements.

- **Meter error calculator** with SMM 400 bus-master without error display
- **Basic meter error calculator** with SMM 400 bus-master and SMM 400 error calculator module
- **Standard evaluation system** with SMM 400+ bus-master and SMM 400+ system evaluation module
- **Extended evaluation system** with SMM 400 Bus-Master, SMM 400+ system evaluation module and addition IN/OUT module for 8 in- and 8 outputs and or COMM communication module

### Functions display and interfaces

- Meter error measurement with scanning head
- Meter error measurement of emitting contacts
- Impulse generator
- Graphic meter error display
- Reset button
- Communication interfaces RS 232, RS 485, CL, M-Bus and ETHERNET

### Options

- **IN/OUT** module for 8 in- and 8 pulse outputs and 10-30 VDC supply for S0 inputs
- **COMM** module with ETHERNET, M-Bus and RS 485 interfaces

## Overview meter evaluation system SMM 400

The system modules are connected with a ring bus. Overview below provides information of the different version.

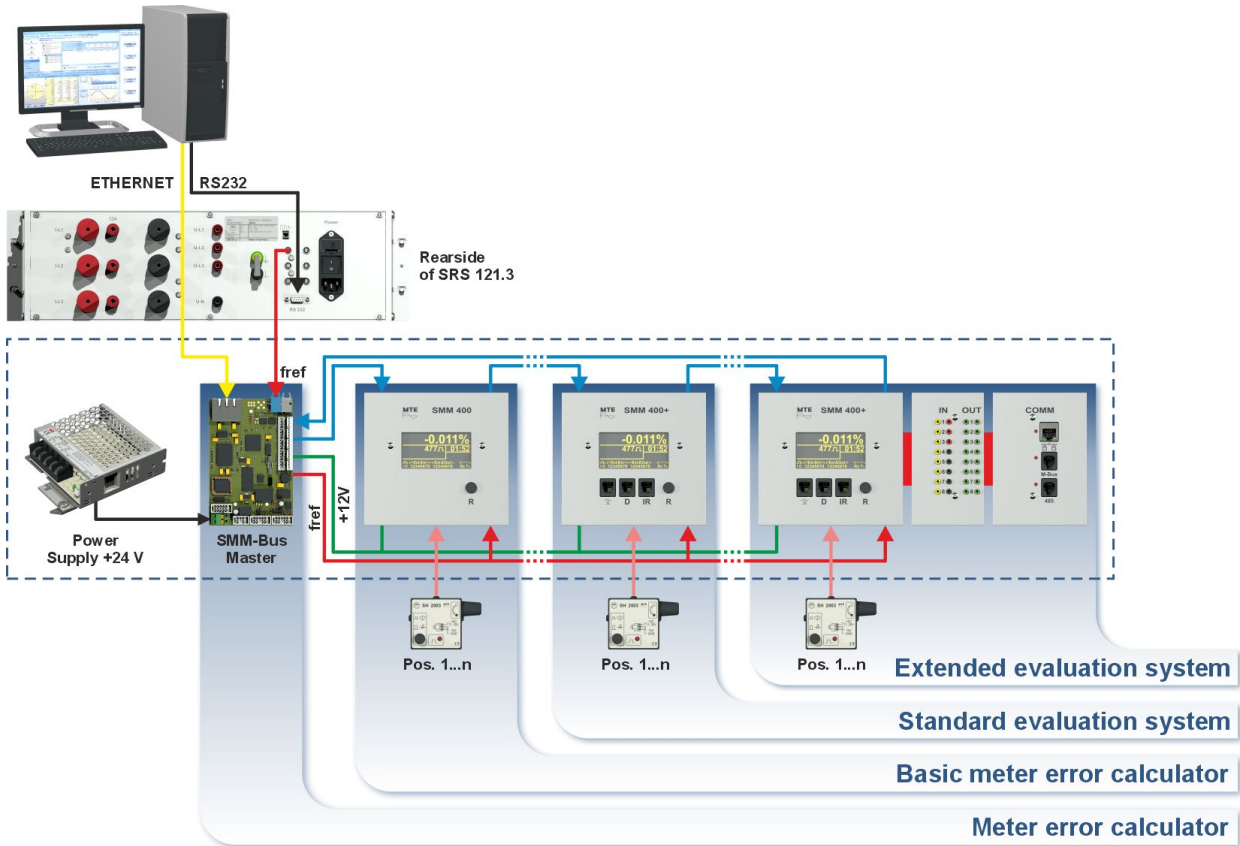

## Modules of Meter Evaluation System SMM 400

### Power Supply



**Power supply** for a 10 position evaluation system with SMM 400 Bus-Master and maximal 10 SMM 400 modules. The unit is built in the system channel by the meter under test.

### SMM 400 Bus-Master

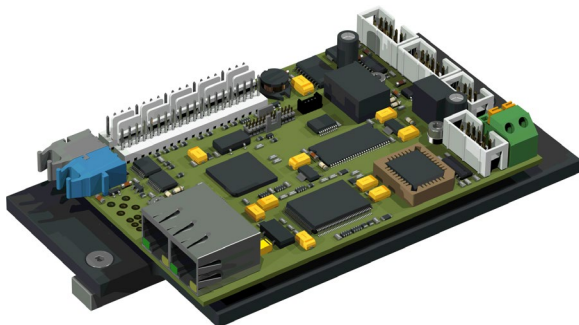

**SMM 400 Bus-Master** provides the interface between personal computer (via ETHERNET) and the system modules over RS 485-Ringbus.

The SMM 400 Bus-Master is equipped with an error calculator for 10 meter position and 10 direct input for scanning head pluses.

### SMM 400 – Error Calculator Module

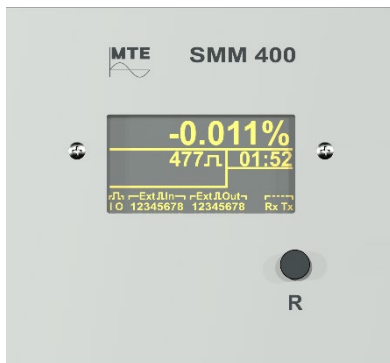

**SMM 400** is a 1 channel error calculator with one input on the rear side for scanning head pulse from SH 2003 or SH 11. A reset-button allows new start of the measurement; the meter error is shown on full graphic OLED Display.

### SMM 400+ – Meter Evaluation Module

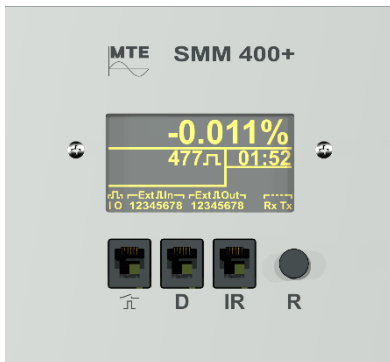

**SMM 400+** Meter Evaluation Module with large color display, Reset button and 2 scanning head pulse inputs is the perfect solution to test modern meter.

The sockets are used for:

Socket : IN and OUT of fast and slow pulses

Socket D: Serial interface RS 232 and 20 mA - current loop interface (CS)

Socket IR: Serial infrared interface e.g. for readout of tariff devices with optical communication head OKK.

### IN/OUT Module

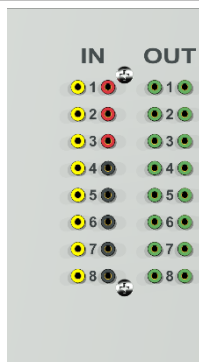

The module **IN/OUT** is equipped with following In- / Outputs:

**8 Pulse inputs (IN)** for testing of meter emitting contacts:

Connector :  $U_{S0}$ : +15 VDC ... +30 VDC

Connector : GND

Connector :  $f_{max} = 500 \text{ Hz}$  /  $t_{on} \geq 1 \text{ ms}$  /  $t_{off} \geq 1 \text{ ms}$

**8 Plus outputs (OUT)** send pre-defined pulse to the meter under test

Connector :  $f_{max} = 100 \text{ Hz}$  /  $t_{on} \geq 1 \text{ ms}$  /  $t_{off} \geq 1 \text{ ms}$  /  $U_{max} = 125 \text{ V}$

### COMM Communication Module

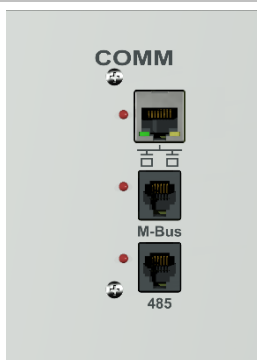

**COMM** is equipped with following interfaces:



- ETHERNET
- M-Bus interface
- RS 485 interface





## Technical Data Evaluation System SMM 400



Auxiliary supply	
Auxiliary voltage:	85 V <sub>AC</sub> ... 264 V <sub>AC</sub> / 47 Hz ... 63 Hz
Power consumption	Less than 0.3 W
Output parameter:	Voltage: 24 V <sub>DC</sub> ± 1 % Power: 78.6 W <sub>max</sub>
Dimensions:	117 mm x 97 mm x 32 mm

SMM 400 Bus-Master	
Auxiliary voltage:	24 V <sub>DC</sub> ± 10 % (max.28 V <sub>DC</sub> )
Power consumption:	≤ 150 mA
Dimensions:	150 mm x 80 mm

SMM 400 Error Calculator Module	
Auxiliary voltage	24 V <sub>DC</sub> ± 10 % (maximal 28 V <sub>DC</sub> )
Power consumption:	≤ 40 mA
Dimensions	130 mm x 120 mm
Display:	Graphic monochrome OLED / 2.7" (61 x 31 mm) / 128 x 64 Pixel

SMM 400+ System Evaluation Module			
Auxiliary voltage	24 V <sub>DC</sub> ± 10 % (maximal 28 V <sub>DC</sub> )		
Power consumption:	≤ 60 mA		
Dimensions:	130 mm x 120 mm		
Display:	Graphic monochrome OLED / 2.7" (61 x 31 mm) / 128 x 64 Pixel		
Connectors:	 Pulse In / and Output	 RS 232 and CL interface	 Data communication interface

IN/OUT Module	
Auxiliary voltage	24 V <sub>DC</sub> ± 10 % (maximal 28 V <sub>DC</sub> )
Power consumption:	≤ 50 mA
Dimensions:	65 mm x 120 mm
Connectors:	Inputs (IN): 8 pc. 2 mm connectors  3 pc. 2 mm connectors  5 pc. 2 mm connectors  Output (OUT): 2 x 8 pc. 2 mm connectors 

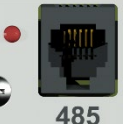
COMM Module			
Auxiliary voltage	24 V <sub>DC</sub> ± 10 % (maximal 28 V <sub>DC</sub> )		
Power consumption:	≤ 40 mA		
Dimensions:	85 mm x 120 mm		
Connectors:	 ETHERNET	 M-Bus Interface	 RS 485 Interface